

* | 124 kW (167 HP) @ 1800 rpm

▲ | 21900 - 23900 kg

📏 | 0.39 - 1.49 m³

* | 138 kW (185 HP) @ 1900 rpm

▲ | 25100 - 26000 kg

📏 | 0.51 - 1.49 m³



DX225LC-3 / DX255LC-3

Crawler Excavator



Doosan – Building your tomorrow today

■ Be part of the great Doosan family

The Doosan Group was founded in 1896. It is headquartered in Seoul, South Korea, and today is one of the fastest growing companies in the world:

From 1896, the first modern local store in Korea



117 years of history

20th century & beyond, major player in various industries all around the world



43100 employees in 34 countries

Today, a global leader in the Infrastructure Support Business (ISB)



Global presence:

- 56 subsidiaries
- 3700 distributors worldwide

AN EXPLOSIVE GROWTH RECORD
DOOSAN GROUP REVENUE

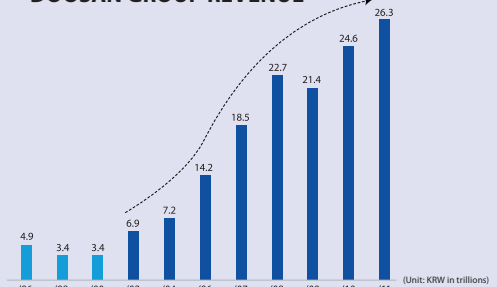

Dramatic growth over the past decade:

- 23% average annual revenue growth since 2000
- From 3.4 to 24.6 KRW trillion between 1998 and 2010



■ Doosan Group



Doosan Engine

- World N° 2 in medium speed marine diesel engines



Doosan Mecatec

- World N° 1 chemical process equipment company
- 60000 tonnes annual production capacity



Doosan Construction & Engineering

A pioneering leader in construction of residential and public buildings, civil works and industrial facilities.



Doosan Heavy Industries & Construction

- World N° 1 in desalination plant
- World N° 1 in heat recovery steam generator area
- World N° 1 in mould & tool steel
- World N° 3 in crankshafts

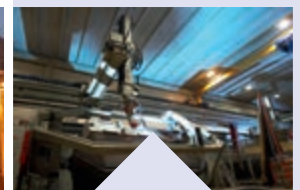

Doosan Infracore

- World N° 1 in compact loaders
- World N° 1 in attachments
- World N° 1 in portable air compressors
- N° 1 in China: 22000 excavators sold in 2010

Doosan – One-stop shop

■ From machine manufacturer... TO FULL SOLUTION PROVIDER

All Doosan Infracore Construction Equipment products are designed and built to deliver the highest levels of performance and productivity. Parts and service support are intended to fully maintain the performance, productivity and reliability expected of our products throughout their entire lifetime as well as ensure the highest trade-in and residual values.

■ Ask your dealer for a full range of services designed for you!

Your dealer is your local specialist to ensure you receive the maximum benefits from our integrated package. Think in advance, think to ensure the success of your equipment!

- ① Genuine parts
- ② Extension of warranty
- ③ Maintenance contract
- ④ Telematics
- ⑤ Monitoring systems
- ⑥ Financial solutions
- ⑦ Doosan approved attachments



Doosan Infracore Construction Equipment

We have been building a global production and business network since 1990 to become one of the world's foremost construction equipment manufacturers. In addition to operating large-scale factories worldwide, we have also established sales subsidiaries, branches and a dealership network all over the globe, making us a truly global player in every respect.



TAKE A TOUR

Large, heavy-duty boom and arm cylinders for smooth, powerful operation

Reinforced forged steel pivot points

Reinforced heavy-duty arm and boom with new optional boom floating system

SLR (only DX225LC-3) and two-piece boom available for improved working range

New work lights with improved illumination (standard: 2 front frame, 4 front & 2 rear cab-mounted, 2 boom mounted and 1 rear side)

All-round visibility with better view through the rear and right windows

Massive maximum bucket and arm digging forces of 15.2 and 12.6 t - DX225LC-3
18.4 and 15.4 t - DX255LC-3

EXPERT CONTROL

- Joystick and switches integrated in the control stand for precise operation. All switches grouped together and ergonomically positioned to the right
- Jog shuttle switch to control various machine functions
- 4 working and 4 power modes for maximum efficiency
- Proportional control (flow/pressure) to operate attachments smoothly and precisely
- New, user-friendly 7" TFT LCD colour monitor with full access to machine settings and maintenance data
- Rear camera and large side mirrors
- Inside cab microphone, straight travel pedal, two pump flow & side camera (optional)

MORE PRODUCTIVITY WITH TOP-NOTCH FUEL EFFICIENCY

Reliable and well protected hydraulic, electric and lubrication routings with simple, optimised layout

MAXIMUM EFFICIENCY

- New powerful DOOSAN DL06K "Common Rail", Stage IIIB compliant, EGR 6 cylinder engine
- e-EPOS System (Electronic Power Optimising System) and hydraulic power boost function for optimised combustion and minimised emissions
- Efficient conversion of engine output into hydraulic performance for better fuel efficiency and lower costs
- Electronic fan clutch that reduces fuel consumption and noise level while improving cooling performance

COMFORTABLE WORKSPACE

- Spacious, newly designed, pressurised ROPS cab with low noise and vibration levels
- Fully adjustable heated air suspension seat as standard
- Large sun roof for extra overhead visibility
- Air conditioning with climate control
- Extra-large door for easy access

EASY MAINTENANCE

- Easy access to all maintenance components
- Maintenance data available directly from control panel
- Fuel pre-filter with water separator
- PC access for maintenance and repairs
- Self-diagnosis function
- Reliable Doosan parts
- Battery cut-off switch and increased capacity (150 Ah)

Extra durable undercarriage with 2 track guards per track frame

SOLID STRENGTH

- Heavy-duty X-shaped undercarriage with integrated track spring and idler plus durable box section track frame
- Undercarriage narrow / standard: 3.00 / 3.20 m (DX255LC-3)
- Increased drawbar pull of 27.5 t (DX225LC-3) - 28.5 t (DX255LC-3)

DX255LC-3

All-round versatility and improved fuel efficiency

■ Expect the best out of your machine

Whatever your application - digging, trenching, levelling, road maintenance, pipe laying or landscaping - you can rely on the DX225LC-3 & DX255LC-3 to take all these tasks in their stride with efficient, dependable performance that saves you time and money.

- Improved hydraulic system using the engine power more effectively, maximising pump output and offering more comfort, smoothness and accuracy
- Increased digging power, swing torque, lifting capacities and traction force combine for performance you can rely on day after day
- Improved fuel efficiency means you can keep costs down and reduce the environmental impact



6 ASSETS TO YOUR BENEFIT!

- Power: DX225LC-3: 124 kW (167 HP) at 1800 rpm – DX255LC-3: 138 kW (185 HP) at 1900 rpm, 6 cylinder engine
- Productivity: side lifting capacity at 6 m reach and 3 m height: DX225LC-3: 4.91 t – DX255LC-3: 6.50 t
- Excavation: max. arm digging force: DX225LC-3: 12.6 t – DX255LC-3: 15.4 t
- Traction: max. drawbar pull: DX225LC-3: 27.5 t – DX255LC-3: 28.5 t
- Manoeuvrability: max. swing torque: DX225LC-3: 82.4 kNm – DX255LC-3: 96.9 kNm
- Size: Ideal dimensions and working range

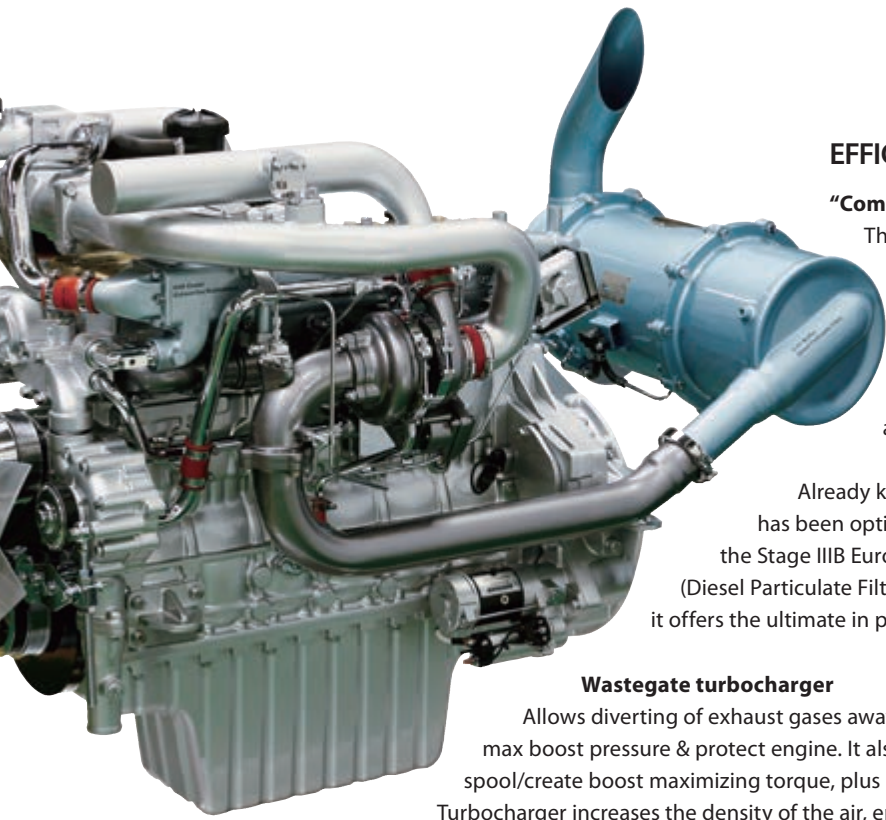

EFFICIENT MANAGEMENT OF FUEL AND HYDRAULICS

“Common Rail” Doosan DL06K engine

The heart of the DX225LC-3 & DX255LC-3 is the “Common Rail” DOOSAN DL06K 6 cylinder engine, carefully designed with common rail injection and 4 valves per cylinder. The engine delivers 124 kW / 169 PS (167 HP) at only 1800 rpm – DX225LC-3 138 kW / 187 PS (185 HP) at only 1900 rpm – DX255LC-3. Powerful torque allows efficient use of the hydraulic system and faster working cycles.

Already known for its outstanding reliability, the DOOSAN DL06K engine has been optimised for the DX225LC-3 & DX255LC-3 and is now compliant with the Stage IIIB European regulations using EGR (Exhaust Gas Recirculation) and DPF (Diesel Particulate Filter). In combination with the e-EPOS electronic control system, it offers the ultimate in power delivery and fuel economy.

Wastegate turbocharger

Allows diverting of exhaust gases away from the turbine wheel to better regulate max boost pressure & protect engine. It also results in less lag time before turbo begins to spool/create boost maximizing torque, plus reduce wear in high rpm & low load conditions.

Turbocharger increases the density of the air, enabling the engine to produce more power with few effects from altitude.



ADVANCED TECHNOLOGY FOR OPTIMUM POWER MANAGEMENT

e-EPOS system (Electronic Power Optimising System)

If the engine is the heart of the excavator, the e-EPOS is its brain. It provides a perfectly synchronised communication link between the engine’s ECU (Electronic Control Unit) and the hydraulic system. A CAN (Controller Area Network) system enables a constant flow of information between the engine and hydraulic system, ensuring power is delivered exactly as needed.

Simple and efficient

- Choice between 4 power modes and 4 working modes guarantees optimum performance in all conditions
- Proportional auxiliary control for attachments
- Regulation and precise control of the flow rate required by the work group
- Self-diagnosis function allows technical problems to be resolved quickly and efficiently
- Operational memory provides a graphic display of the machine status
- Maintenance and oil change intervals can be displayed

Quick and efficient

The main hydraulic pumps have an increased capacity, reducing cycle times for heightened productivity. A high capacity gear pump improves pilot line efficiency.

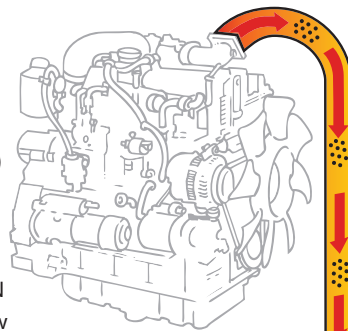

EGR with diesel particulate filter

EGR, which requires enhanced cooling capacity, reduces NOx by recirculating exhaust back into the engine. This dilutes the amount of oxygen in the combustion chamber and lowers the combustion peak temperature.

Exhaust

Exhaust with higher PM concentration goes in.

Cleaned exhaust with lower PM (Particulate Matter) concentration comes out.

Diesel Particulate Filter filters exhaust to remove PM.

DOC (Diesel Oxidation Catalyst) reacts with exhaust and transforms PM emissions into harmless substances.

Fuel efficiency

- Auto-idle function enables fuel saving (lowered from 1000 to 800 rpm)
- New electronic fan clutch optimizes cooling for more fuel savings
- ECO gauge: monitors fuel consumption to maintain economic operation
- Improved Main Control Valve (MCV) performance reduces energy loss
- Additional sensor allows a more efficient selection of flow/pressure/rpm according to load requirements

ECO Gauge and ECO symbol

The ECO gauge shows the average fuel efficiency for 1 minute’s operation. The ECO symbol changes from green to amber, red and grey colour to show the workload when using the equipment.

Electronic viscous fan clutch

For optimum cooling, fan speed is controlled electronically by a fan clutch, resulting in lower fan noise and better fuel efficiency.

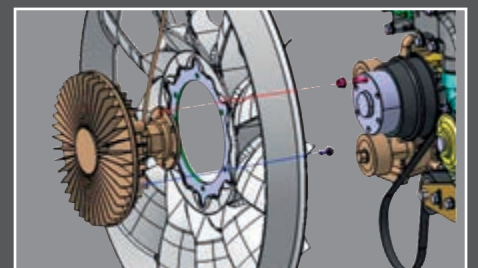
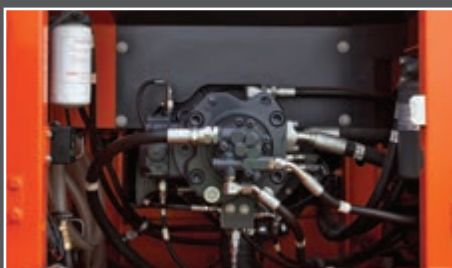

The ideal workspace – designed around you

The DX225LC-3 & DX255LC-3 are designed to provide you with the best possible working conditions. The sophisticated pressurised ROPS cab is ISO-certified for your safety. Its spacious interior offers a fully adjustable, heated air suspension seat. Comfortably seated, you have easy access to several storage compartments and a clear all-round view of the worksite. Noise and vibration levels have been reduced while air conditioning and automatic climate control allow you to maximize your productivity and return on investment.



Heated air suspension seat (standard)

As well as being adjustable and offering lumbar support, the seat has an air suspension system to reduce vibrations. It also features a button to activate the seat heating system. A storage box has been placed under the seat for extra convenience.



Storage space

Plenty of storage space means you can keep all your personal belongings within reach. The new cab contains 7 storage spaces including one hot/cool box.

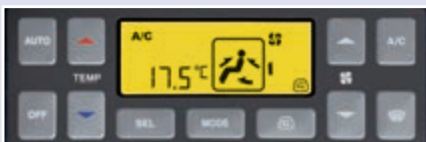

Air conditioning with climate control

The electronically controlled air conditioning system features 5 different operating modes allowing the operator to adjust the airflow to suit conditions. A recirculated air function is also available.



MP3/USB radio and USB port

A USB port (standard) allows connection of an MP3 player (MP3/USB radio with CD player optional).



ERGONOMIC OPERATOR ENVIRONMENT

Feel the comfort of a seat that fits you perfectly:

Using a dual positioning cursor, you can slide the seat back from the joysticks for the best working position. You can also slide the entire seat assembly to adjust the reach to the control pedals to your leg length.

- 1 Large sun roof
- 2 Sun visor
- 3 Robust ergonomic pedals
- 4 Flat, spacious, easy-to-clean floor
- 5 Upper front window is strut-assisted for easy, reliable adjustment and integrates a sun shade
- 6 Joysticks and switches are integrated in adjustable control consoles
- 7 Separate seat height adjustment lever and cushion tilting function
- 8 Storage compartment for sunglasses
- 9 Hot/cool box
- 10 Photo sensor detects radiant energy of the sun and adjusts temperature automatically

Cab suspension

The cab features a new suspension system that combines high vibration dampening with outstanding protection against impact. The system absorbs shocks and vibrations much more effectively than a conventional viscous suspension system.



Maximum controllability in every situation

Doosan's unique new jog shuttle switch gives you easy, precise control over all machine functions. Proportional auxiliary flow means that the excavator's huge power is matched by smooth, confident manoeuvres. Using highly sensitive joysticks and clear controls positioned for convenient access, you are able to work safely and confidently with minimum effort. Even the switches have been ergonomically placed on the right-hand control stand and positioned according to the frequency with which they are used. The highest standards of efficiency are just a finger's reach away.



Jog shuttle control switch

- Power mode and Work mode
- Auto-idle / Buzzer Stop
- Adjustments of rpm, hydraulic flow and pressure for attachments
- Rear view camera
- Multimedia: - video: AVI (DivX®), MP4, WMV
- audio: MP3
- Menu change or selection

Colour LCD monitor panel

The upgraded 7" TFT LCD panel features a day and night display and has been relocated within the operator's line of sight. The monitor is user-friendly and gives full access to machine settings and maintenance data. Any abnormality is clearly displayed on the screen, allowing you to work safely and confidently with an accurate overview of all conditions. All functions are totally controllable, directly via the screen or using the Jog shuttle switch.



4 Work modes to suit your application

- 1-way mode and 2-way mode
- Digging mode and lifting mode

4 Power modes for maximum efficiency

- Power plus mode
- Power mode
- Standard mode
- Economy mode

Gauges

- Engine coolant and hydraulic oil temperatures
- Fuel level
- Eco symbol: changes colour when operating conditions change (idle, normal or loading)
- Eco gauge: shows the average fuel efficiency for 1 minute of operation
- Warning symbols



4 Work modes



4 Power modes



Auto-idle

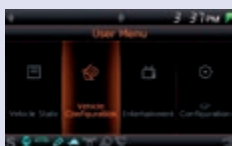

User menu

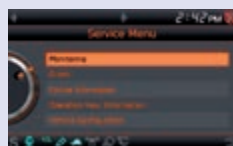

Service menu



Attachment presets



Filter/oil information



Anti-theft protection

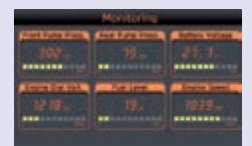

Monitoring

Your safety – our biggest concern

- A rear view camera shows you a clear view of what's happening behind the machine. A side view camera is also available as an option for jobs requiring extra safety measures
- Cab and boom lights are fitted as standard, greatly enhancing safety on night-time jobs
- Large side mirrors improve all-round visibility (ISO compliant)

Other standard safety features include: automatic overheating prevention, low oil pressure sensor, engine emergency cut-off switch, auxiliary mode switch (to stop the pump if the control system malfunctions), overload warning device. An optional travel/swing alarm is also available.

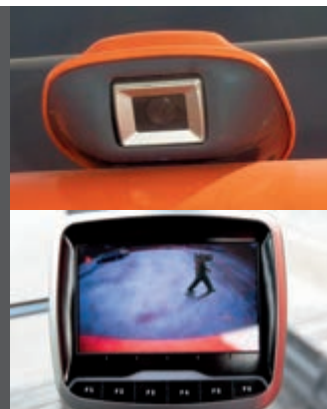

Excellent digging and lifting performance provides quick cycle times.



Simple operation

- “Short stroke” joysticks enable easy, precise control of all operations
- A thumb wheel switch and buttons on the joysticks allow proportional control of attachments such as grabs, crushers and grapples
- A straight travel pedal can be installed to facilitate operation when moving in a straight line



Dynamic power management

- Automatic travel speed function
- Activation of the power boost control system increases digging power by 10%
- A one-touch deceleration button immediately reduces engine speed to low or idle
- Auto-idling starts after 4 seconds at low rpm. This decreases fuel consumption and reduces noise levels in the cab
- Jog shuttle dial for engine rpm

Floating boom function (optional)

- The intelligent floating boom mode allows the boom to move up and down freely when external force is applied.
- The breaker mode restricts the boom to downward movement only. This means that the breaker can be operated using only the weight of the work group on the front, without additional force. The breaker remains in constant contact with the object. The result is reduced shock and vibration and longer breaker service life.
- During truck loading, the lowering of the boom can be controlled without hydraulic pump flow discharge. This increases productivity and fuel efficiency.

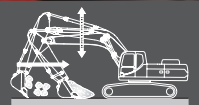

Quality you can rely on

■ Designed for long-term all-round heavy duty operation

In your profession, you need equipment you can depend on. At DOOSAN, we use highly specialised design and analysis tools to make sure our machines are as robust and durable as can be. Our materials and structures undergo stringent testing for strength and resilience in the most extreme conditions.

RESILIENT CHAIN FOR TOP CLASS RELIABILITY

The DX225LC-3 and DX255LC-3 are fitted with the same super-strong chain. The 19.0 cm link pitch, 3.8 cm pin diameter and heavy-duty running gear are ideally suited for long, trouble-free service in the roughest conditions.

- Track chains: the sealed and lubricated track chains are specifically designed for better pin and bushing retention. Exclusive heat treatment gives the links a consistent surface and strong core hardness, enhancing their durability
- Track guards: two guards per track frame (standard) protect against track derailment

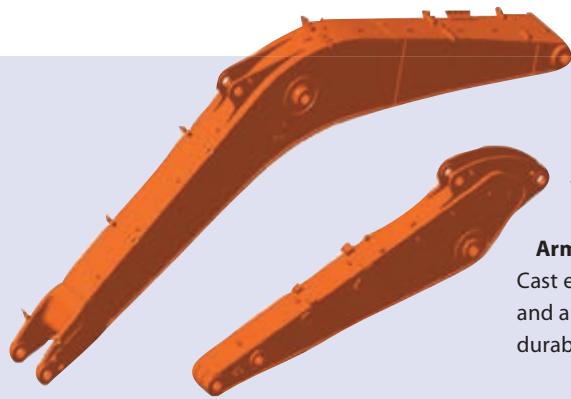

Strengthened boom

Finite Element Analysis (FEA) has been used to calculate the best load distribution throughout the boom structure. Combined with increased material thickness, this means that element fatigue is limited and both reliability and component life are increased.

Arm assembly

Cast elements and reinforcements have been added to give the arm assembly greater strength and a longer lifetime. The arm link boss and side plates have been combined for increased durability.

Protected hydraulics

The hydraulic line routing is straight and simple for a neat, compact design that enhances its durability and minimizes the pressure lost.



Extra-strong X-chassis

The X-shaped undercarriage has been designed using Finite Element Analysis and 3D computer simulation to ensure optimum structural integrity and durability. The swing gear is solid and stable.

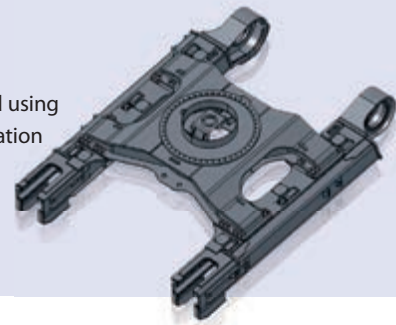

Heavy-duty sprocket

The sprocket is deep induction hardened and the depth pattern on the entire tooth profile is optimised for long-lasting service. Cast steel sprockets guarantee the highest resistance and durability even in the most severe applications. The sprocket tooth shape has been redesigned to prevent popping and increase component life.

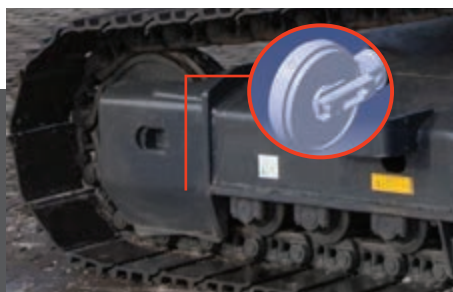

Integrated track spring and idler

The track spring and idler have been joined together for long-lasting performance and convenient maintenance. A new seal and cylinder body rod have been used to avoid leakage. Special heat treatment ensures optimum hardness and long-lasting resistance to wear.

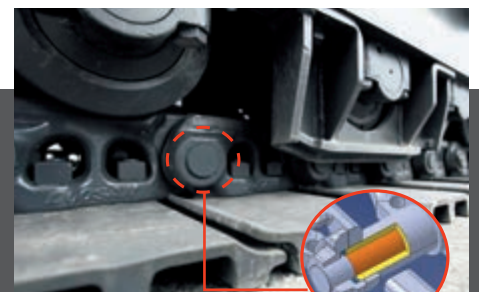

Tracks

For long-term dependability in all conditions, the chain is composed of sealed, self-lubricating links which are isolated from all external contamination. The tracks are locked by mechanically bolted pins. In areas subjected to great stress, the track link thickness has been reinforced.



The heavy-duty undercarriage provides excellent stability and durability. It is designed to excel in tough working environments.



Extra robust parallel dozer

- ❶ Large reinforced covers protect the dozer and stabilizer cylinders.
- ❷ The shape of the dozer blade is designed to facilitate pulling and mixing of materials.
- ❸ Dozer forward design, large working angle and reinforced components to ensure optimum stability when lifting or while working on sloped terrain.



Cast counterweight and steel compartment access

A cast counterweight minimises deformation resulting from external impact. Operating stability has been increased by use of a low centre of gravity design. All external compartment panels are made of steel for extra durability.

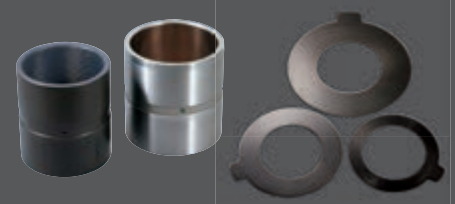

Bushing and polymer shim

A highly lubricated metal is used for the boom pivot in order to increase the component lifetime and extend the greasing intervals. A polymer shim is added to the bucket pivot to maintain precise control over the equipment and extend greasing intervals.

More value – less maintenance

Short maintenance operations at long intervals mean you can depend on your equipment being available on site when it's needed. The DX225LC-3 & DX255LC-3 are designed for simple routine maintenance, while skilled Doosan technicians are available to provide extra support when you need it. You can choose the package you need from a broad range of service agreements to get the most out of your machine. Uptime, productivity and residual value are all maximised, making these excavators an economical and rewarding choice.



Maintenance access made simple

- Large handrails are installed along with anti-slip steps and plates, for safer, easier access to the engine compartment
- The cab's air conditioning filter is lockable and placed on the side of the cab for easy access
- A battery cut-off switch makes it easy to disconnect the battery during long-term storage
- The hour meter display can be easily checked from ground level
- Cock valves have been fitted on the pre-filter piping line and fuel tank drain piping to make servicing easier and prevent pollution from leakage

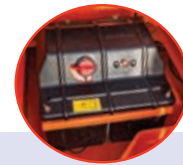

Access to components

- Engine parts can be easily reached via the top and side panels
- Access to the various radiators and filters is very easy, making routine maintenance easier

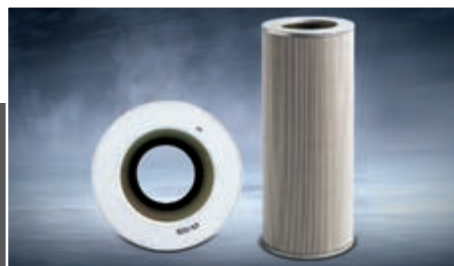

Protective oil return filter

The protection of the hydraulic system is made more effective by the use of glass fibre technology in the main oil return filter. With more than 99.5% of foreign particles filtered out, the oil change interval is extended.



Fuel pre-filter with water separator sensor

High efficiency fuel filtration is attained by the use of multiple filters. These include a fuel pre-filter fitted with a water separator that removes moisture, dirt and debris from the fuel. A warning sensor is added to each fuel filter to indicate when water draining is required.



Engine oil filter

The engine oil filter offers a high level of filtration allowing a long interval between changes. It is easy to access and is positioned to avoid contaminating the surrounding environment.

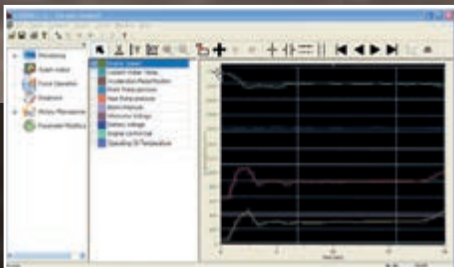

PC monitoring

A PC monitoring function enables connection to the e-EPOS system. Thus, various parameters can be checked during maintenance, including pump pressures and engine speed. This information can be saved and printed for analysis



Convenient fuse box

The fuse box is located in the storage compartment behind the seat, providing a clean environment and convenient access.



DPF regeneration switch

Regeneration is automatic and doesn't interfere with operation. When the level of soot is too high, a warning symbol alerts the operator that he can activate regeneration at any time.



Centralised greasing points

To make maintenance easier, the greasing points have been centralised.

Technical specifications

* Engine

• Model

Doosan DL06K
4-Cycle Water-Cooled, Turbocharged,
Common Rail Direct Injection, Exhaust Gas Recirculation
Diesel Particulate Filter (DPF)

• No. of cylinders

6

• Rated power **DX225LC-3 / DX255LC-3**

121 kW (165 PS) at 1800 rpm / 134 kW (182 PS) at 1900 rpm (DIN 6271)
124 kW (167 HP) at 1800 rpm / 138 kW (185 HP) at 1900 rpm (SAE J1995)
121 kW (163 HP) at 1800 rpm / 134 kW (180 HP) at 1900 rpm (SAE J1349)

• Max. torque at 1400 rpm **DX225LC-3 / DX255LC-3**

77 kgf/m (755 Nm) / 82 kgf/m (804 Nm)

• Idle (low - high) **DX225LC-3 / DX255LC-3**

800 [± 20] - 1900 [+25/-50] rpm / 800 [± 20] - 2000 [+25/-50] rpm

• Piston displacement

5890 cm³

• Bore x stroke

100 mm x 125 mm

• Starter

24 V / 6.0 kW

• Batteries – Alternator

2 x 12 V / 150 Ah – 24 V, 80 A

• Air filter

Double element with automatic dust evacuation.

* Weight

	Shoe width (mm)	Operating weight (t)		Ground pressure (kgf/cm ²)	
		DX225LC-3	DX255LC-3	DX225LC-3	DX255LC-3
Triple grouser	600 (Std)	21.9	25.1	0.46	0.51
	700	22.2	25.4	0.40	0.44
	800	22.5	25.7	0.36	0.39
	900	22.8	26.0	0.32	0.35

* Undercarriage

Very robust construction throughout. All welded structures designed to limit stresses. High-quality, durable materials. Lateral chassis welded and rigidly attached to undercarriage. Track rollers lubricated for life. Idlers and sprockets fitted with floating seals. Track shoes made of induction-hardened alloy with triple grouser. Heat-treated connecting pins. Hydraulic track adjuster with shock-absorbing tension mechanism.

• Number of rollers and track shoes per side **DX225LC-3 / DX255LC-3**

Upper rollers (standard shoe): 2 (ø 142 mm) / 2 (ø 142 mm)
Lower rollers: 8 (ø 154 mm) / 10 (ø 160 mm)
Number of links & shoes per side: 49 / 51
Overall track length: 4445 / 4625 mm

* Hydraulic system

The brain of the excavator is the e-EPOS (Electronic Power Optimizing System). It allows the efficiency of the hydraulic system to be optimised for all working conditions and minimises fuel consumption. The e-EPOS is connected to the engine's electronic control unit (ECU) via a data transfer link to harmonise the operation of the engine and hydraulics.

- The hydraulic system enables independent or combined operations
- Two travel speeds offer either increased torque or high speed
- Cross-sensing pump system for fuel savings
- Auto deceleration system
- Four operating modes, four power modes
- Button control of flow in auxiliary hydraulic circuits
- Computer-aided pump flow control

* Pumps

Pump	Type	Displacement (cm ³ /rev)	Max. flow (l/min)		Relief valve pressure (kgf/cm ²)
			DX225LC-3 @ 1800 rpm	DX255LC-3 @ 1900 rpm	
Main (2)	Tandem, Axial piston	2 x 115	2 x 206	2 x 219	-
Pilot	Gear	15	27	28.5	40.0

• Maximum system pressure

Boom/arm/bucket	
Work/travel:	DX225LC-3: 330 kg/cm ² [+10/0] DX255LC-3: 349 kg/cm ² [+10/0]
Rotation:	DX225LC-3: 270 kg/cm ² DX255LC-3: 275 kg/cm ²
Power:	DX225LC-3: 350 kg/cm ² [+10/0] DX255LC-3: 370 kg/cm ² [+10/0]

* Hydraulic cylinders

Piston rods and cylinder bodies of high-strength steel. Shock-absorbing mechanism fitted in all cylinders for shock-free operation and extended piston life.

Cylinders	Quantity	Bore x rod diameter x stroke (mm)	
		DX225LC-3	DX255LC-3
One-piece boom	2	125 x 85 x 1263	130 x 90 x 1365
Arm	1	140 x 100 x 1450	140 x 100 x 1655
Bucket	1	120 x 80 x 1060	125 x 85 x 1080
Two-piece boom	2	125 x 85 x 1263	130 x 90 x 1335
Two-piece boom, lower	1	150 x 100 x 1300	160 x 100 x 1300
Two-piece boom, upper	1	140 x 100 x 1450	140 x 100 x 1655
Bucket SLR	1	95 x 65 x 900	-

* Swing mechanism

- High-torque, axial piston motor with planetary reduction gear bathed in oil
- Swing circle: single-row, shear type ball bearing with induction-hardened internal gear
- Internal gear and pinion immersed in lubricant
- Max. swing speed: DX225LC-3: 0 to 10.9 rpm / DX255LC-3: 0 to 9.9 rpm
- Max. swing torque: DX225LC-3: 8400 kgf/m (Eff.=80% : 6689 kgf/m)
DX255LC-3: 9880 kgf/m (Eff.=82% : 8127 kgf/m)

* Drive

Each track is driven by an independent, high-torque axial piston motor through a planetary reduction gearbox. Two levers / foot pedals guarantee smooth travel with counter-rotation on demand.

- **Travel speed (low - high)** DX225LC-3 / DX255LC-3
3.0 - 5.5 km/h / 3.2 - 5.6 km/h
- **Maximum traction (low - high)** DX225LC-3 / DX255LC-3
14.9 - 27.5 t / 16.6 - 28.5 t
- **Maximum gradeability**
35° / 70%

* Fluid capacities

- **Fuel tank** DX225LC-3 / DX255LC-3
400 l / 410 l
- **Cooling system (radiator capacity)** DX225LC-3 / DX255LC-3
22.3 l / 28 l
- **Hydraulic oil tank** DX225LC-3 / DX255LC-3
200 l / 240 l
- **Engine oil** DX225LC-3 / DX255LC-3
27 l / 27 l
- **Swing drive** DX225LC-3 / DX255LC-3
5 l / 7 l
- **Travel device** DX225LC-3 / DX255LC-3
2 x 3.3 l / 2 x 3.9 l

* Environment

Noise levels comply with environmental regulations (dynamic values).

- **Noise level LwA** DX225LC-3 / DX255LC-3
Guaranteed: 103 dB(A) / 104 dB(A) (2000/14/EC)
Measured: 102 dB(A) / 102 dB(A) (2000/14/EC)
- **Operator LpA**
70 dB(A) (ISO 6396)

* Buckets

Bucket Type	DX225LC-3										Bucket Type	DX255LC-3													
	Capacity (m³)		Width (mm)		Weight (kg)	One-piece boom: 5700 mm			Two-piece boom: 5850 mm			SLR boom: 8500 mm	Capacity (m³)		Width (mm)		Weight (kg)	One-piece boom: 5900 mm Standard track / Narrow track			Two-piece boom: 6090 mm Standard track / Narrow track				
	SAE	With side cutters	W/O side cutters	Arm: 2400 mm		Arm: 2900 mm	Arm: 3500 mm	Arm: 2400 mm	Arm: 2900 mm	Arm: 6200 mm			SAE	With side cutters	W/O side cutters	Arm: 2500 mm		Arm: 3000 mm	Arm: 3500 mm	Arm: 2500 mm	Arm: 3000 mm	Arm: 3500 mm			
DC*	0.45	-	1500	357	-	-	-	-	-	A		0.51	722	772	529	A/A	A/A	A/A	A/A	A/A	A/A	A/A	A/A	A/A	
GP	0.39	820	736	330	-	-	-	-	-	A	GP	0.81	1064	1128	654	A/A	A/A	A/A	A/A	A/A	A/A	A/A	A/A	A/A	
	0.51	772	722	529	A	A	A	A	A	-		0.92	1173	1236	697	A/A	A/A	A/A	A/A	A/A	A/A	A/A	A/A	A/A	
	0.81	1128	1065	654	A	A	A	A	A	-		1.05	1309	1372	751	A/A	A/A	A/A	A/A	A/A	A/A	A/A	A/A	A/A	A/A
	0.92	1236	1173	697	A	A	A	A	A	-		1.10	1316	1377	836	A/A	A/A	A/A	A/A	A/A	A/A	A/A	A/B	A/B	A/B
	1.05	1372	1309	751	A	A	B	A	B	-		1.17	1430	1493	809	A/A	A/A	A/A	A/A	A/A	A/A	A/A	A/B	A/B	A/B
	1.17	1493	1430	809	A	B	C	B	C	-		1.28	1544	1607	976	A/A	A/B	A/B	A/A	A/B	A/B	B/C	B/C	B/C	B/C
	1.28	1607	1544	848	B	C	D	C	C	-		1.40	1607	1668	848	A/A	A/B	A/B	A/B	B/C	B/C	B/C	B/C	B/C	B/C
HD	0.73	982	916	732	A	A	A	A	A	-	HD	0.73	916	982	732	A/A	A/A	A/A	A/A	A/A	A/A	A/A	A/A	A/A	
	0.90	1130	1064	804	A	A	A	A	A	-		0.90	1064	1130	804	A/A	A/A	A/A	A/A	A/A	A/A	A/A	A/A	A/A	
	1.07	1286	1220	864	A	B	C	A	B	-		1.07	1220	1286	864	A/A	A/A	A/A	A/A	A/A	A/A	A/A	A/A	A/A	
	1.24	1438	1372	923	B	C	D	C	C	-		1.24	1372	1438	923	A/A	A/A	A/B	A/A	A/B	A/B	B/C	B/C	B/C	
	1.32	1516	1450	967	C	C	D	C	D	-		1.32	1450	1516	967	A/A	A/B	B/B	A/B	B/B	A/B	B/C	B/C	B/C	
	1.49	1666	1600	1039	C	D	-	D	D	-		1.49	1600	1666	1039	A/B	B/C	C/C	B/C	C/C	B/C	C/C	C/D	C/D	

A: Suitable for materials with a density less than or equal to 2100 kg/m³

B: Suitable for materials with a density less than or equal to 1800 kg/m³

(*) Ditch Cleaning. Based on ISO 10567 and SAE J296 arm length without quick-coupler. For reference only.

C: Suitable for materials with a density less than or equal to 1500 kg/m³

D: Suitable for materials with a density less than or equal to 1200 kg/m³

* Digging forces (ISO)

DX225LC-3 Shoe: 600 mm		Boom: 5.7 m Arm: 2.9 m Bucket: 0.92 m³ Counterweight: 4.3 t	Boom: 5.7 m Arm: 2.4 m Bucket: 1.05 m³ Counterweight: 4.3 t	Boom: 5.7 m Arm: 3.5 m Bucket: 0.81 m³ Counterweight: 4.3 t	SLR Boom: 8.5 m Arm: 6.2 m Bucket: 0.39 m³ Counterweight: 5.3 t	Two-piece boom: 5.85 m Arm: 2.9 m Bucket: 0.81 m³ Counterweight: 4.3 t	Two-piece boom: 5.85 m Arm: 2.4 m Bucket: 0.92 m³ Counterweight: 4.3 t
BUCKET (Normal / Press. Up)	t	14.3 / 15.2	14.3 / 15.2	14.3 / 15.2	9.4 / 10.0	14.3 / 15.2	14.3 / 15.2
	kN	140.2 / 149.0	140.2 / 149.0	140.2 / 149.0	140.2 / 149.0	140.2 / 149.0	140.2 / 149.0
ARM (Normal / Press. Up)	t	10.2 / 10.8	11.9 / 12.2	9.1 / 9.7	5.6 / 6.0	10.0 / 10.8	11.9 / 12.2
	kN	100.0 / 105.9	116.7 / 119.6	89.2 / 95.1	54.9 / 58.8	100.0 / 105.9	116.7 / 119.6

DX255LC-3 Shoe: 600 mm		Boom: 5.9 m Arm: 3.0 m Bucket: 1.10 m³	Boom: 5.9 m Arm: 2.5 m Bucket: 1.17 m³	Boom: 5.9 m Arm: 3.5 m Bucket: 0.92 m³	Two-piece boom: 6.09 m Arm: 3.0 m Bucket: 1.10 m³	Two-piece boom: 6.09 m Arm: 2.5 m Bucket: 1.17 m³	Two-piece boom: 6.09 m Arm: 3.5 m Bucket: 0.92 m³
BUCKET (Normal / Press. Up)	t	17.0 / 17.9	17.0 / 17.9	17.0 / 17.9	17.0 / 17.9	17.0 / 17.9	17.0 / 17.9
	kN	166.7 / 175.5	166.7 / 175.5	166.7 / 175.5	166.7 / 175.5	166.7 / 175.5	166.7 / 175.5
ARM (Normal / Press. Up)	t	12.1 / 12.8	14.6 / 15.4	11.1 / 11.7	12.1 / 12.8	14.6 / 15.4	11.1 / 11.7
	kN	118.6 / 125.5	143.2 / 151.0	108.8 / 114.7	118.7 / 125.5	143.2 / 151.0	108.8 / 114.7

Dimensions

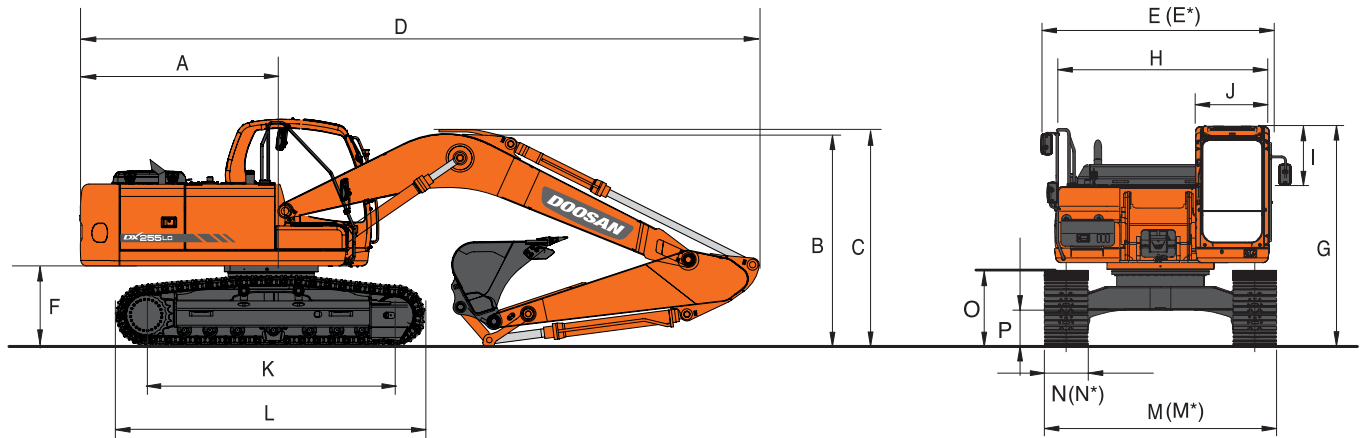

* Dimensions mono and two-piece boom

	DX225LC-3						DX255LC-3					
	One-piece boom: 5700		Two-piece boom: 5850		SLR boom: 8500	One-piece boom: 5900			Two-piece boom: 6090			
	2900	2400	3500	2400	2900	6200	3000	2500	3500	3000	2500	3500
	Boom length - mm											
	Arm length - mm											
	Bucket capacity - m ³											
A	2790	2790	2790	2790	2790	2790	2995	2995	2995	2995	2995	2995
B	2870	2970	3130	3100	3080	3190	2995	3080	3380	3110	3090	3460
C	3005	3130	3330	3100	3080	3275	3200	3300	3555	3110	3090	3460
D	9490	9540	9540	9690	9680	12355	10035	10100	10060	10215	10240	10145
E	2990	2990	2990	2990	2990	2990	3200	3200	3200	3200	3200	3200
E*	-	-	-	-	-	-	3000	3000	3000	3000	3000	3000
F	1055	1055	1055	1055	1055	1055	1110	1110	1110	1110	1110	1110
G	2975	2975	2975	2975	2975	2975	2970	2970	2970	2970	2970	2970
H	2710	2710	2710	2710	2710	2710	2710	2710	2710	2710	2710	2710
I	845	845	845	845	845	845	845	845	845	845	845	845
J	1010	1010	1010	1010	1010	1010	1010	1010	1010	1010	1010	1010
K	3650	3650	3650	3650	3650	3650	3835	3835	3835	3835	3835	3835
L	4445	4445	4445	4445	4445	4445	4625	4625	4625	4625	4625	4625
M	2990	2990	2990	2990	2990	2990	3200	3200	3200	3200	3200	3200
M*	-	-	-	-	-	-	3000	3000	3000	3000	3000	3000
N	600	600	600	600	600	600	600	600	600	600	600	600
N*	-	-	-	-	-	-	600	600	600	600	600	600
O	947	947	947	947	947	947	992	992	992	992	992	992
P	480	480	480	480	480	480	450	450	450	450	450	450

* Component weights

Item	unit	DX225LC-3	DX255LC-3	Remarks
Upper structure without front	kg	9970	11355	with counterweight
Counterweight std.	kg	4300 (5300 for SLR)	5000	
Lower structure assembly	kg	7646	8886	
Front assembly	kg	4083	4758	
Boom	kg	1670 (5700 mm)	1670 (5900 mm)	including bushing
Arm	kg	651 (2900 mm)	816 (3000 mm)	including bushing
Bucket	kg	697 (0.92 m ³)	836 (1.10 m ³)	
Boom cylinder (each)	kg	180	206	
Arm cylinder	kg	257	284	
Bucket cylinder	kg	145	172	
Two-piece boom	kg	1945 (5850 mm)	2084 (6090 mm)	
Two-piece boom, boom cylinder	kg	178	205	
Two-piece boom, cylinder	kg	270	292	
Two-piece boom, arm cylinder	kg	259	288	
Arm	kg	566 (2400 mm)	708 (2500 mm)	
Arm	kg	793 (3500 mm)	921 (3500 mm)	
Dozer blade (2990 mm)	kg	899	-	Dozer cylinder (each) 90 kg
Boom SLR (8500 mm)	kg	1884	-	
Arm SLR (6200 mm)	kg	1056	-	
Lower structure assembly narrow	kg	-	8790	

Working range

DX225LC-3

DX255LC-3

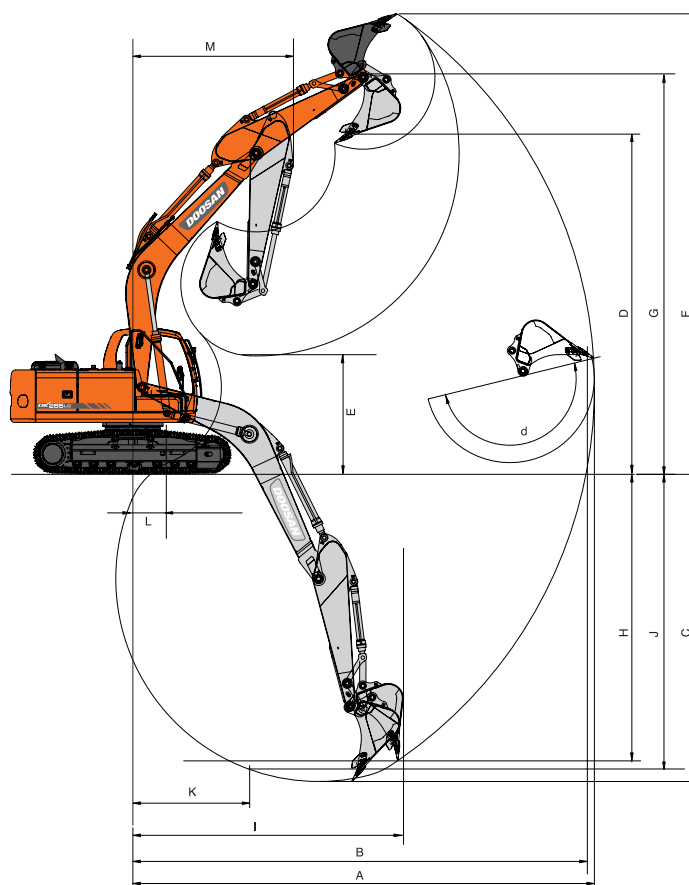

* Working range mono and two-piece boom

	DX225LC-3						DX255LC-3					
	One-piece boom: 5700			Two-piece boom: 5850			SLR boom: 8500	One-piece boom: 5900			Two-piece boom: 6090	
Boom length - mm	2900	2400	3500	2400	2900	6200	3000	2500	3500	3000	2500	3500
Arm length - mm	0.92	1.05	0.81	0.92	0.81	0.39	1.10	1.17	0.92	1.10	1.17	0.92
Bucket capacity - m ³	9885	9470	10390	9680	10110	15380	10175	9650	10605	10485	9950	10935
A Max. digging reach - mm	9710	9280	10220	9500	9940	15265	9995	9455	10430	10310	9765	10765
B Max. digging reach (ground) - mm	6585	6080	7190	5980	6460	11650	6810	6310	7315	6735	6205	7210
C Max. digging depth - mm	6840	6700	6980	8010	8310	10845	7025	6650	7170	8645	8155	8960
D Max. loading height - mm	2500	3010	1900	3920	3320	1900	2600	3100	2090	3500	4100	3090
E Min. loading height - mm	9560	9450	9660	10910	11200	13075	9705	9275	9820	11545	11030	11850
F Max. digging height - mm	8295	8155	8440	9465	9770	12075	8500	8120	8640	10115	9625	10430
G Max. bucket pin height - mm	5625	5365	5975	4955	5355	9710	5200	4450	5520	4680	4655	5645
H Max. vertical wall depth - mm	6380	6025	6740	6355	6620	10065	7225	7215	7520	7765	7235	7560
I Max. radius vertical - mm	6400	5880	7020	5760	6265	11550	6630	6075	7145	6635	6095	7105
J Max. digging depth (8' level) - mm	2855	2865	2825	2200	2110	4850	2960	2875	2945	1700	1700	1750
K Min. radius 8' line - mm	510	1685	-230	510	510	155	690	1865	190	-	-	-
L Min. digging reach - mm	3580	3580	3620	2790	2625	4960	3720	3730	3745	2935	3080	3285
M Min. swing radius - mm	177	177	177	177	177	177	174	174	174	174	174	174
d Bucket angle - °												



Lifting capacities

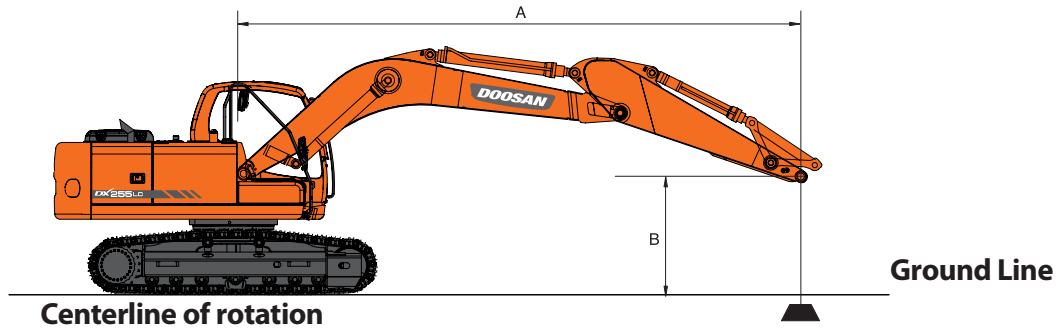

DX225LC-3 – Standard configuration

Standard track width: 2990 mm • Boom: 5700 mm • Arm: 2900 mm • W/O Bucket • Shoe: 600 mm • Counterweight: 4300 kg

Units: 1000 kg

B (m)	A (m)		3.0		4.5		6.0		7.5		Max. lift		A (m)
	1.5	3.0	3.0	4.5	4.5	6.0	6.0	7.5	7.5	Max. lift	Max. lift		
7.5							* 4.96	* 4.96			* 4.27	* 4.27	6.22
6.0							* 5.39	5.33			* 3.98	3.81	7.32
4.5							* 5.92	5.16	* 5.47	3.62	* 3.92	3.24	8.00
3.0					* 8.68	7.51	* 6.74	4.91	5.45	3.51	* 4.03	2.96	8.35
1.5					* 10.29	7.00	7.45	4.67	5.32	3.39	* 4.30	2.86	8.42
0 (Ground)			* 6.15	* 6.15	* 11.05	6.73	7.26	4.5	5.22	3.31	4.59	2.92	8.22
-1.5	* 6.72	* 6.72	* 10.61	* 10.61	* 10.94	6.66	7.18	4.43	5.2	3.29	5.00	3.17	7.72
-3.0	* 11.43	* 11.43	* 13.89	13.11	* 9.98	6.73	7.23	4.47			5.98	3.77	6.86
-4.5			* 10.55	* 10.55	* 7.69	6.97					* 5.92	5.31	5.47

DX225LC-3 – Option 1 Two-piece boom

Standard track width: 2990 mm • Boom: 3100 mm LB + 2800 mm UB • Arm: 2900 mm • W/O Bucket • Shoe: 600 mm • Counterweight: 4300 kg

Units: 1000 kg

B (m)	A (m)	Dozer	3.0		4.5		6.0		7.5		Max. lift		A (m)
			3.0	4.5	4.5	6.0	6.0	7.5	Max. lift	Max. lift			
9.0		Without			* 5.69	* 5.69					* 4.89	* 4.89	4.80
		Dozer up			* 5.69	* 5.69					* 4.89	* 4.89	4.80
7.5		Without			* 6.14	* 6.14	* 5.53	5.44			* 4.09	* 4.09	6.53
		Dozer up			* 6.14	* 6.14	* 5.53	* 5.53			* 4.09	* 4.09	6.53
6.0		Without			* 6.26	* 6.26	* 6.31	5.4	* 4.23	3.66	* 3.80	3.58	7.59
		Dozer up			* 6.26	* 6.26	* 6.31	5.71	* 4.23	3.89	* 3.80	* 3.80	7.59
4.5		Without	* 11.29	* 11.29	* 8.71	8.17	* 6.76	5.19	* 5.39	3.61	* 3.72	3.06	8.24
		Dozer up	* 11.29	* 11.29	* 8.71	8.61	* 6.76	5.49	* 5.39	3.85	* 3.72	3.27	8.24
3.0		Without			* 10.18	7.47	* 7.60	4.89	5.48	3.48	* 3.78	2.79	8.58
		Dozer up			* 10.18	7.91	* 7.60	5.19	* 5.66	3.71	* 3.78	2.99	8.58
1.5		Without			* 10.87	6.88	7.46	4.6	5.33	3.34	* 3.99	2.70	8.65
		Dozer up			* 10.87	7.32	* 7.99	4.9	* 6.01	3.57	* 3.99	2.89	8.65
0 (Ground)		Without			* 10.53	6.59	7.25	4.41	5.22	3.24	* 4.39	2.75	8.45
		Dozer up			* 10.53	7.03	* 7.86	4.71	6.03	3.47	* 4.39	2.95	8.45
-1.5		Without	* 9.36	* 9.36	* 9.28	6.53	* 7.11	4.34	5.19	3.22	* 4.55	2.98	7.97
		Dozer up	* 9.36	* 9.36	* 9.28	6.97	* 7.11	4.64	* 5.26	3.45	* 4.55	3.2	7.97
-3.0		Without			* 7.14	6.63	* 5.48	4.39			* 3.79	3.53	7.13
		Dozer up			* 7.14	7.07	* 5.48	4.7			* 3.79	3.77	7.13

DX225LC-3 – Option 3 SLR

Standard track width: 2990 mm • Boom: 8500 mm • Arm: 6200 mm • W/O Bucket • Shoe: 800 mm • Counterweight: 5300 kg













Units: 1000 kg

B (m)	A (m)		3.0		4.5		6.0		7.5		9.0		10.5		12.0		13.5		Max. lift		A (m)
	1.5	3.0	3.0	4.5	4.5	6.0	6.0	7.5	7.5	9.0	9.0	10.5	10.5	12.0	12.0	13.5	13.5	Max. lift	Max. lift		
12.0																			* 2.06	* 2.06	9.81
10.5												* 2.39	* 2.39						* 1.91	* 1.91	11.17
9.0												* 2.34	* 2.34	* 2.27	1.98				* 1.83	* 1.83	12.19
7.5												* 2.40	* 2.40	* 2.40	1.98				* 1.79	1.65	12.97
6.0												* 2.54	2.52	* 2.47	1.94	* 1.84	1.49		* 1.79	1.48	13.52
4.5												* 2.96	* 2.96	2.40	* 2.58	1.87	2.39	1.46	* 1.81	1.36	13.90
3.0			* 9.26	* 9.26	* 6.25	* 6.25	* 4.66	* 4.66	* 3.82	* 3.82	* 3.31	2.93	* 2.97	2.27	* 2.73	1.78	2.34	1.41	* 1.86	1.28	14.10
1.5					* 7.91	7.15	* 5.58	4.85	* 4.38	3.56	* 3.67	2.72	* 3.21	2.13	2.77	1.69	2.28	1.36	* 1.95	1.23	14.14
0 (Ground)			* 3.74	* 3.74	* 7.36	6.45	* 6.30	4.41	* 4.86	3.27	* 4.00	2.53	3.29	2.01	2.69	1.61	2.23	1.31	* 2.07	1.22	14.02
-1.5	* 3.61	* 3.61	* 4.53	* 4.53	* 7.13	6.13	* 6.75	4.14	5.14	3.07	3.97	2.39	3.19	1.91	2.62	1.55	2.2	1.28	2.14	1.24	13.74
-3.0	* 4.58	* 4.58	* 5.50	* 5.50	* 7.78	6.02	6.93	4.00	5.00	2.95	3.87	2.29	3.12	1.84	2.58	1.51			2.24	1.3	13.27
-4.5	* 5.59	* 5.59	* 6.62	* 6.62	* 8.89	6.04	* 6.87	3.96	4.95	2.90	3.83	2.25	3.09	1.81	2.57	1.50			2.41	1.41	12.62
-6.0	* 6.69	* 6.69	* 7.90	* 7.90	* 8.64	6.15	* 6.57	4.00	4.97	2.91	3.84	2.26	3.11	1.83					2.70	1.59	11.73
-7.5	* 7.90	* 7.90	* 9.42	* 9.42	* 7.75	6.35	* 5.99	4.12	* 4.79	2.99	* 3.87	2.33	* 3.05	1.92					* 3.00	1.91	10.57
-9.0			* 8.57	* 8.57	* 6.37	* 6.37	* 5.00	4.32	* 3.96	3.16	* 2.99	2.50							* 2.99	2.50	9.00

DX255LC-3 – Standard configuration

Standard track width: 3200 mm • Boom: 5900 mm • Arm: 3000 mm • W/O Bucket • Shoe: 600 mm • Counterweight: 5000 kg













Units: 1000 kg

A (m) \ B (m)	1.5		3.0		4.5		6.0		7.5		Max. lift		A (m)	
														
7.5								* 6.42	* 6.42			* 4.91	* 4.91	6.64
6.0								* 6.55	* 6.55	* 5.44	4.89	* 4.64	* 4.64	7.67
4.5								* 7.31	6.81	* 6.68	4.82	* 4.61	4.07	8.31
3.0					* 10.92	9.95		* 8.39	6.50	6.92	4.67	* 4.75	3.76	8.64
1.5					* 12.92	9.33		* 9.44	6.19	6.76	4.52	* 5.07	3.65	8.70
0 (Ground)			* 6.81	* 6.81	* 13.84	9.01		9.24	5.99	6.63	4.41	5.56	3.72	8.49
-1.5	* 7.80	* 7.80	* 11.84	* 11.84	* 13.72	8.93		9.14	5.90	6.59	4.37	6.03	4.02	8.00
-3.0	* 12.98	* 12.98	* 17.57	* 17.57	* 12.66	9.01		9.19	5.94			7.11	4.71	7.17
-4.5			* 13.84	* 13.84	* 10.20	9.26						* 7.41	6.41	5.83

DX255LC-3 – Option 1

Standard track width: 3200 mm • Boom: 5900 mm • Arm: 3000 mm • W/O Bucket • Shoe: 800 mm • Counterweight: 5000 kg













Units: 1000 kg

A (m) \ B (m)	1.5		3.0		4.5		6.0		7.5		Max. lift		A (m)	
														
7.5								* 6.42	* 6.42			* 4.91	* 4.91	6.64
6.0								* 6.55	* 6.55	* 5.44	4.94	* 4.64	* 4.64	7.67
4.5								* 7.31	6.88	* 6.68	4.87	* 4.61	4.12	8.31
3.0					* 10.92	10.05		* 8.39	6.56	7.00	4.72	* 4.75	3.80	8.64
1.5					* 12.92	9.43		* 9.44	6.26	6.83	4.57	* 5.07	3.69	8.70
0 (Ground)			* 6.81	* 6.81	* 13.84	9.11		9.35	6.05	6.71	4.46	5.62	3.76	8.49
-1.5	* 7.80	* 7.80	* 11.84	* 11.84	* 13.72	9.03		9.25	5.97	6.67	4.42	6.11	4.07	8.00
-3.0	* 12.98	* 12.98	* 17.57	* 17.57	* 12.66	9.11		9.29	6.01			7.19	4.76	7.17
-4.5			* 13.84	* 13.84	* 10.20	9.36						* 7.41	6.48	5.83

DX255LC-3 – Option 2 Narrow

Narrow track width: 3000 mm • Boom: 5900 mm • Arm: 3000 mm • W/O Bucket • Shoe: 600 mm • Counterweight: 5000 kg













Units: 1000 kg

A (m) \ B (m)	1.5		3.0		4.5		6.0		7.5		Max. lift		A (m)	
														
7.5								* 6.42	* 6.42			* 4.91	* 4.91	6.64
6.0								* 6.55	6.51	* 5.44	4.51	* 4.64	4.34	7.67
4.5								* 7.31	6.28	* 6.68	4.44	* 4.61	3.75	8.31
3.0					* 10.92	9.07		* 8.39	5.97	6.90	4.30	* 4.75	3.45	8.64
1.5					* 12.92	8.47		* 9.44	5.67	6.73	4.15	* 5.07	3.35	8.70
0 (Ground)			* 6.81	* 6.81	* 13.84	8.16		9.20	5.47	6.61	4.04	5.54	3.41	8.49
-1.5	* 7.80	* 7.80	* 11.84	* 11.84	* 13.72	8.08		9.11	5.39	6.57	4.00	6.01	3.69	8.00
-3.0	* 12.98	* 12.98	* 17.57	15.91	* 12.66	8.16		9.15	5.42			7.08	4.31	7.17
-4.5			* 13.84	* 13.84	* 10.20	8.40						* 7.41	5.87	5.83



DX255LC-3 – Option 3 Two-piece boom

Narrow track width: 3000 mm • Two-piece boom: 3050 mm LB + 3050 mm UB • Arm: 3000 mm • W/O Bucket • Shoe: 600 mm • Counterweight: 5000 kg

Units: 1000 kg

A (m) \ B (m)	3.0		4.5		6.0		7.5		9.0		Max. lift		A (m)
													
9.0			* 7.49	* 7.49							* 5.56	* 5.56	5.50
7.5					* 7.10	6.73					* 4.80	* 4.80	7.04
6.0			* 7.31	* 7.31	* 7.69	6.62	* 6.56	4.58			* 4.49	4.05	8.02
4.5			* 11.01	9.91	* 8.77	6.35	* 6.87	4.48			* 4.40	3.53	8.63
3.0			* 12.70	9.09	* 9.51	5.99	6.91	4.31			* 4.47	3.26	8.95
1.5			* 13.64	8.43	9.42	5.66	6.72	4.14	* 4.75	3.18	* 4.69	3.17	9.01
0 (Ground)			* 13.30	8.14	9.18	5.45	6.59	4.02			* 5.10	3.24	8.81
-1.5	* 9.71	* 9.71	* 11.92	8.09	9.09	5.37	6.55	3.99			* 5.67	3.50	8.33
-3.0			* 9.56	8.21	* 7.49	5.43	* 5.02	4.09			* 4.91	4.07	7.54

- Lifting capacities are in compliance with ISO 10567:2007(E).
- The load point is at the end of the arm.
- * = The nominal loads are based on hydraulic capacity.
- The nominal loads shown do not exceed 75% of tipping loads or 87% of hydraulic lifting capacity.
- For lifting capacity with bucket, simply subtract the actual weight of the bucket from the values.
- The configurations indicated do not necessarily reflect the standard equipment of the machine.

 : Rating over front
 : Rating over side or 360°



* Standard equipment

Engine
DOOSAN DL06K Diesel engine combined with e-EPOS System, Common Rail direct injection, EU Stage IIIB compliant, EGR
Diesel particulate filter (DPF)
Auto-idle
Hydraulic system
Boom and arm flow regeneration
Swing anti-rebound valves
Spare ports (valve)
One-touch power boost
Breaker piping
Cylinder cushioning & contamination seals
Control of auxiliary hydraulic flow and pressure from the display panel
Cab & Interior
Roll Over Protective Structure (ROPS)
Pressurised, sound-insulated and CabSus mounted cab
Heated, adjustable air suspension seat with adjustable headrest and armrest
Jog shuttle switch with attachment management system
Air conditioning with climate control
Pull-up type front window with sun roller blind and removable lower front window
Sliding left windows with lock
Ceiling light
Intermittent upper windshield wiper
Multiple storage compartments (e.g. document holder under seat)
Rain visor
Flat, spacious, easy-to-clean floor
Cigarette lighter and ashtray
Cup holder
Anti-theft protection
Hot and cool box
Fuel control dial
7" (18 cm) LCD colour monitor panel
Engine speed (RPM) control dial
Hydrostatic 2-speed travel system with manual or automatic shift
Automatic rear window defroster
4 operating modes & 4 working modes
Radio-ready and remote radio ON/OFF switch
12 V power socket
Serial communication port for laptop PC interface
Adjustable PPC wrist control levers for arm, boom, bucket and swing, with sliding proportional control for attachments, auxiliary hydraulic buttons and one-touch power boost
USB port & auxiliary input
Diesel particulate filter regeneration switch
Tool storage area
Travel pedals and hand levers
Master key
Safety
Boom and arm cylinder safety valves
Overload warning device
Large handrail and step
Rotating beacon
Rear view camera
Punched metal anti-slip plates
Hydraulic safety lock lever
Safety glass
Hammer for emergency escape
Right and left rearview mirrors
Emergency engine stop and hydraulic pump control switches
Engine overheat and restart prevention system
Parking brake and cab swing lock pin
Reinforced cast steel pivot points
Upperstructure maintenance compartment doors and lockable fuel cap
Battery cut-off switch
Halogen work lights (2 front frame, 4 front cab-mounted, 2 rear cab-mounted, 2 boom-mounted and 1 rear side)
Mirror on counterweight
Other
Mono boom: DX225LC-3: 5700 mm – arm: 2900 mm
Mono boom: DX255LC-3: 5900 mm – arm: 3000 mm
Counterweight: DX225LC-3: 4300 kg / DX255LC-3: 5000 kg
Auto shut-off fuel filler pump
Double element air cleaner
Fuel pre-filter with water separator sensor
Dust screen for radiator/oil cooler
Separated engine hoods with gas spring. DPF hood screwed & protected
Self-diagnostic function
Battery (2 x 12 V, 150 Ah), alternator (24 V, 80 A)
Electric horn
Remote greasing for swing circle and workgroup pivot points
Guards for boom lights
Undercarriage
Fixed undercarriage DX225LC-3: 2990 mm / DX255LC-3: 3200 mm
Hydraulic track adjuster
Normal track guards
Greased and sealed track links
600 mm triple grouser shoe

* Optional equipment

Cab & Interior
MP3/USB radio or MP3/USB radio with CD player
Safety
FOGS cab - top and front cab guards (ISO 10262)
Front window upper and lower guards
Side view camera
2 Lateral safety bars (ISO 2867:2011)
Other
Two-piece boom: DX225LC-3: 5850 mm with 2400 or 2900 mm arm
Two-piece boom: DX255LC-3: 6090 mm with 2500, 3000 or 3500 mm arm
SLR DX225LC-3: boom: 8500 mm with 6200 mm arm and 5300 kg counterweight
Arms: DX225LC-3: 2400 mm or 3500 mm / DX255LC-3: 2500 mm or 3500 mm
Doosan buckets: full range of GP, HD & Rock buckets
Doosan breaker: DXB190H and Doosan quick-couplers
Hydraulic piping for crusher, quick coupler, clamshell, tilting and rotating buckets
Additional filter for breaker piping
Floating boom function
Wiper for lower front window
Double pump flow
Water separator with heater
Engine coolant heater
Plug heater
Additional 12 V power socket
Straight travel pedal
Telescopic rotating beacon
Bio oil
Automatic lubrication system
Microphone
Alarm for travel & swing
Alarm for travel
Undercarriage
Narrow fixed undercarriage DX255LC-3: 3000 mm
700, 800 & 900 mm triple grouser shoe
DX225LC-3: Dozer blade 2990, 3090, 3190 & 3290 mm



Dozer blade (on DX225LC-3)
For dozing and working on sloped terrains. It also increases stability when lifting.

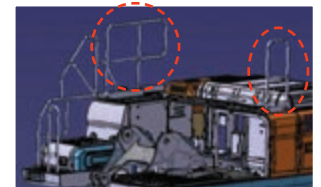

2 additional lateral safety bars
With raised height for increased safety.

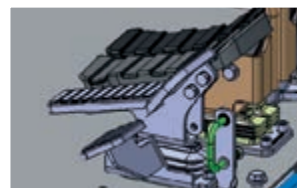

Straight travel pedal
Allows more operator comfort when multi-tasking.



Engine coolant heater
Improves start-up ability in extremely cold conditions by heating coolant and fuel.



Doosan buckets
A range of dependable Doosan buckets is available to cover several applications.



Doosan breakers and quick-couplers
Doosan provides the tough, reliable equipment you need for demolition work.

Some of these options may be standard in some markets. Some of these options may not be available for certain markets. Please check with your local DOOSAN dealer for more information about availability or to adapt your machine to your application needs.



Doosan Infracore Construction Equipment

A partner you can trust



**Finance
your
ambitions**



www.doosanequipment.eu

Financial Solutions

Doosan Infracore Financial Services (DI FS) is specialised in creating financing solutions to meet a wide variety of needs. Contact your local dealer for more information.

Always a dealer near you

Our well-developed dealer network has the knowledge and experience to take the best care of our Doosan customers. No matter where you are, you'll get the service you expect - and can rely on!

Parts & Service

- Complete parts & service support for all Doosan products
- Highest quality genuine parts
- Large, dedicated staff of factory-trained aftermarket professionals in the field



www.doosanequipment.eu

